



a *Door* for all
seasons

Secure & beautiful all year round

Solidor.

solidor.co.uk

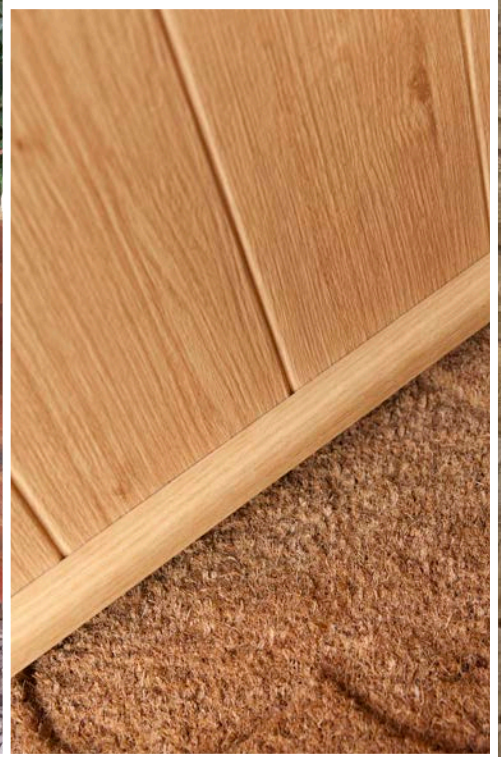
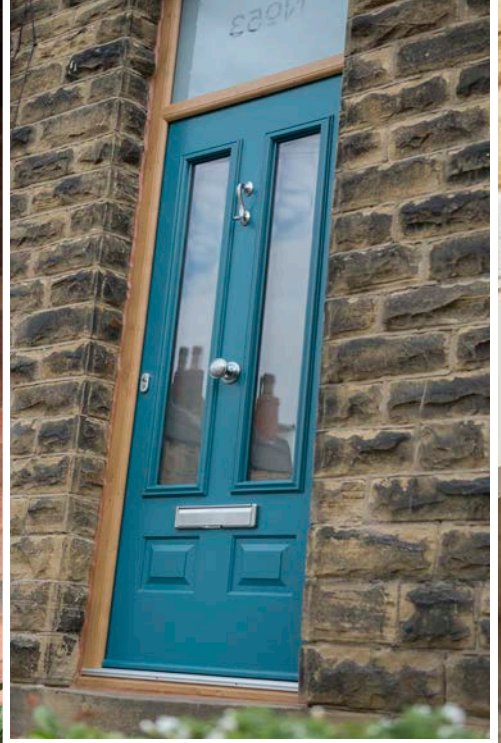

2006

BOND HOUSE



Solidor®

Leading the way in secure
composite doors



Introduction

The Solidor Collection is an outstanding range of industry leading, solid laminate, timber core composite doors. Each Solidor exceeds building regulation requirements and combines traditional and contemporary styling with a full range of Secured by Design locking which provides a stunning, high quality and secure entrance to any home.

With a thickness of 48mm, a Solidor door is nearly 10% thicker than most alternatives. Each unique solid timber core is completely encapsulated within a highly durable plastic edge banding and two thermo plastic door skins. This means that your customer will never have to worry about painting or varnishing their Solidor.

These doors are exclusively available in the widest range of styles and frame colour options, (20 colours available, please see page 10) with the option of a mobility threshold, making it the perfect solution for easy wheel or push chair access. We offer a comprehensive range of matching coloured frames, that are available with either glass, composite side panel or quarter panel to compliment the look of any property.

Solidor composite doors are manufactured to the highest standards. We hold BSI Kite mark accreditation BSI ISO 9001 for quality management, BSI EN1279 for insulating glass units.

We are also PAS24:2016 certified, hold CE Marking and Secured by design licences, are members of the prestigious GGF and Association of Composite Doors.

Contents

- 05. Choosing Solidor
- 06. Security
- 08. Colour Options
- 10. The Solidor Promise
- 12. Italia Collection
- 21. London
- 22. Alnwick
- 23. Edinburgh
- 24. Berkeley
- 25. Conway
- 26. Ludlow
- 28. Nottingham
- 29. Harlech
- 30. Tenby
- 31. Beeston
- 32. Flint
- 34. Stafford
- 35. Windsor
- 35. Thornbury
- 36. French Doors
- 38. Stable Doors
- 40. Side Panels
- 42. Glass Options
- 46. Accessories
- 49. Finishing Options

PLEASE NOTE THE IMAGES SHOWN WITHIN THIS BROCHURE ARE FOR ILLUSTRATION PURPOSES ONLY

Choosing Solidor®

We understand that knowing your home and family are protected is a major factor when choosing your new doors.

You can rest assured that with our door construction, coupled with our unique, reinforced door frame and Secured by Design locking systems, your property will be as safe as can be when you choose Solidor.

The Comparison



A typical foam filled construction

- Only a small section of the door is actually solid.
- Thermally good, but foam filled so not solid, nor secure.
- Gel coated GRP may be strong but it scratches very easily and can be cut through.
- Most other doors have frames containing lead stabilisers.
- The frames are only 3 chambers thick and use valuable steel or aluminium reinforcements.
- Can be cut through in 90 seconds



Solidor® construction

- Lead free, 5 chamber profile with 100% recycled reinforcing.
- Thermally efficient Solid Timber Core.
- Robust through colour thermo plastic skins.
- Realistic wood grain effect.
- Optional integral mobility access aluminium threshold.

**PAS 24
- 2016
CERTIFIED**

7/10 COMPOSITE DOORS ARE
NOT PAS24: - 2016 READY,
SOLIDOR IS!

To see our security test video visit www.solidor.co.uk/tv



Security

The **most secure** composite door on the market



Lock options

The Largest Deadbolt in the UK

Our exclusive Avantis Secured by Design lock gives you the industry's largest 25.4mm dead bolt for added security. It also has built in compression and dampeners to give the smoothest operation on the market.

Key Operated Multi Lock

If you don't want a handle on your door, you can choose our key operated multi point lock.

Heritage Automatic Slam Shut

The aesthetics of a traditional rim latch, but incorporating the latest high security multi point lock. It activates and locks the door automatically once the door is shut. The Heritage lock comes with a thumbturn cylinder as standard.

The automatic AV2 mechanical lock

The automatic AV2 mechanical lock operates as a slam secure lock as soon as the door is closed. AV2 B allows home owners to unlock the door from a distance using a remote control device.

Yale Key Free Handle

The Yale Key Free connected smart lock gives you the freedom to secure your home without the need for a key. It is simple to use, and gives you complete control of how you open your door.

*Module for smart home system not included

Supreme Security Accreditations

Solidor have obtained the highest standards of security and quality

The **only** hardwood core composite door on the market



ULTION

Fitted on every Solidor as standard

STAYS LOCKED



ULTION MAKES THE UK'S MOST SECURE COMPOSITE DOOR EVEN MORE BURGLAR PROOF

When it detects attack, a hidden lock within the Ultion automatically engages, so that even when snapped twice nothing gets past it. Leaving a key on the inside of the lock won't affect its performance either.

Ultion has passed tests that even the finest 3 star locks can't achieve, making it the UK's best and most secure lock guaranteed.

.....
£1000
GUARANTEE



**IF AN INTRUDER BREAKS INTO YOUR HOME AS A RESULT OF
SNAPPING ULTION, ULTION WILL PAY YOU £1000**



Molybdenum Alloy Core
25% denser than Iron

Resistance Sections
Sacrificed when snapped

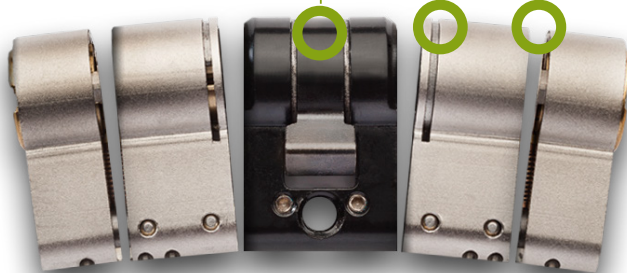

Watch the Ultion v's a standard cylinder video at www.solidor.co.uk/tv

Choose from 11,000+ Colour Options

We offer the *largest range* of colours from stock in the UK. Choose from *20 colours* inside and/or outside of the door, with *18 frame combinations*.

RAL Colour Match

for Solidor Door Skins

White Skins - RAL 9016

Blue Skins - RAL 5011

Green Skins - RAL 6009

Red Skins - RAL 3011

Black Skins - RAL 9005

Anthracite Grey - RAL 7016

French Grey - RAL 7001

Rich Aubergine - RAL 4007

Painswick - RAL 7038

Cream - RAL 9001

Foiled White - RAL 9010

Schwarzbraun - RAL 8022

Chartwell Green

RAL 6021 (not a perfect match)
or BS14C35 Iceplant Green

Duck Egg Blue

BRITISH STANDARD RANGE
4800/5252 REF 20-C-33

Irish Oak - Foiled Material

Golden Oak - Foiled Material

Rosewood - Foiled Material

Walnut - Foiled Material

Peacock Blue - BS381C103

Golden Sand - RAL 1002

✱ Available as a door and/or
a frame option

Be inspired...

Introducing 2 brand new colour finishes for your Solidor. The best colour for your door depends a lot on the style of your house, but as a guide, traditional homes generally suit rich colours such as Peacock Blue, while modern homes suit more contemporary shades, such as warm greys or our 'Golden Sand'

With Solidor, you can mix and match! For example, Chartwell Green on White outer frame with Duck Egg Blue on French Grey door.

New!

Luxury Range
Peacock Blue

Luxury Range
Golden Sand

Luxury Range
Duck Egg Blue

Luxury Range
Walnut

Luxury Range
Painswick

*Due to the limitations of the lithographic printing process, colour samples may not be an exact match to actual doors.



The Solidor Promise

At Solidor we are committed to doing our part in helping the environment, believing that the future of our planet is important, not only for ourselves, but for the future of our children. With many industry firsts already, we are always looking to pioneer greener products and methods.

That's why we minimise our waste and run an extensive recycling programme. We recycle all of our packaging, polystyrene, cardboard, PVC-u, timber, paper, aluminium and steel. All of the timbers used in our doors are harvested from forests which are managed to meet the social, economic and ecological needs of present and future generations.

Our Green Credentials

Timber can make a significant contribution to sustainable construction

1. Wood is naturally renewable
2. It is independently certified to be sourced from sustainably managed forests
3. Doors with timber cores save energy
4. They last longer
5. They add to our quality of life
6. They have fewer environmental impacts than other materials
7. Complies with minimum U-value requirements for building regulations



- 100% recycled thermally efficient reinforcing system
- 5 chamber lead free thermally efficient profile
- Extensive recycling programme
- Door can be recycled at the end of its useful life, not destined for land fill
- Fully manufactured in the UK to minimise our carbon footprint
- Lead free door skins and edge banding



CONTEMPORARY

Italia Collection

The Italia collection from Solidor is a new generation of truly contemporary designs which will add a touch of style to your home. Carefully designed and crafted from the finest materials, every door in the Italia collection has a definite style inspired by the Italian passion for design.

Each door is handmade in Staffordshire, ensuring the finished product is of an outstanding quality and made as individual as can be. Choose from a range of glass styles and door furniture which have been carefully chosen with the latest fashion and designs in mind. All of the doors in the Italia Collection are also available with Warwick Glass - hand made so no two pieces are ever the same.

As with any product from Solidor, you can be assured of the outstanding quality of our solid laminate 48mm timber core composite doors which combine modern styling with high security locking systems.

Milano

Milano in Anthracite Grey with ES3 1800 door handle and key only security locking option

All Italia doors are available with or without grooves



Brescia

Brescia in French Grey with ES3 1800 door handle and key only security locking option



Genoa

Genoa in Golden Oak, ES3 800 door handle and key only security locking option.



Sorrento

Sorrento in Cream with ES3 400 door handle and key only security locking option

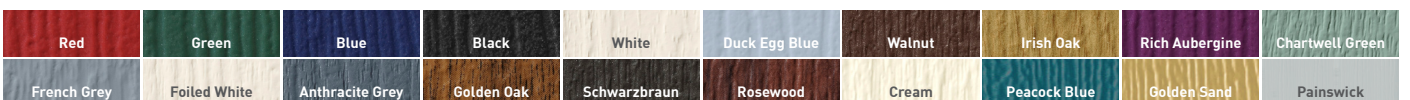

Amalfi

Amalfi in Golden Sand with Matrix glass and ES21 door handle



Modena

Modena in Anthracite Grey with ES24 door handle and key only security locking option



Siena

Siena in Luxury Walnut with ES23 door handle, abstract glass and key only security locking option



Pisa

Pisa in Chartwell Green with ES23 door handle, abstract glass and key only security locking option



Parma

Parma in Schwarzbraun, with ES3 1800 door handle, Potomac glass and key only security locking option

All Italia doors are available with or without grooves



Messina

Messina in Rosewood, ES3 800 door handle and key only security locking option



Venice

Venice in Peacock Blue and Warwick glass with ES3 1800 door handle and key only security locking option



Garda

Garda in Painswick, with ES24 door handle, solid stainless steel knocker, Satin glass and key only security locking option

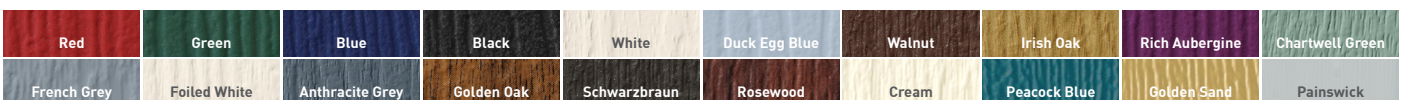

Palermo

Palermo in Luxury Walnut with ES3 1800 door handle



Naples

Naples in Schwarzbraun with Bullseye glass. Chrome finish handle with multipoint locking option



Biella

Biella in Foiled White with chrome lever handle and multi point locking



Rimini

Rimini in Irish Oak, with ES3 1800 door handle, Satin glass and key only security locking option

All Italia doors are available with or without grooves



Roma

Roma in Golden Sand with Bullseye glass, ES21 door handle and key only security locking option



Ancona Solid

Ancona Solid in Golden Oak with ES3 1800 door handle and key only security locking option

Monza

Monza in Painswick with ES21 door handle, Satin glass and key only security locking option



Red	Green	Blue	Black	White	Duck Egg Blue	Walnut	Irish Oak	Rich Aubergine	Chartwell Green
French Grey	Foiled White	Anthracite Grey	Golden Oak	Schwarzbraun	Rosewood	Cream	Peacock Blue	Golden Sand	Painswick

Bologna

Bologna in Painswick with Bullseye glass, ES 24 door handle and key only security locking option



Turin

Turin in Chartwell Green with Abstract glass, Chrome finish handle and multi point locking



Ancona

Ancona in Cream and CTB18.1 glass with EK53 door handle and key only security locking option



Verona

Verona Solid in Duck Egg Blue with ES3 1800 door handle and key only security locking option. Available with grooves



Contemporary Italia Glass (see pages 42-45)

	Garda	Amalfi	Ancona	Biella	Bologna	Brescia	Messina	Milano	Naples	Palermo	Pisa	Roma	Siena	Sorrento	Turin	Monza	Parma	Rimini
Abstract										✓		✓		✓				
Brillante														✓				
Bullseye				✓			✓	✓			✓						✓	
CFT 2.1														✓				
Clarity - Gold only														✓				
CRL 2.1														✓				
CTB 17.1														✓				
CTB 19.1														✓				
Diamond Glass														✓				
Elegance														✓				
Etched Squared		✓				✓												
Linear		✓				✓												
Matrix		✓				✓												
Modena																✓		
Park Lane Bespoke															✓	✓		
Potomac										✓		✓		✓	✓	✓		
Prarie														✓				
Quad Glass														✓				
Reflections														✓	✓			
Royale														✓				
Simplicity														✓				
Trio Square Glass														✓				

Diamond Glass available in Red / Black / Butterscotch / Black and White

Quad Glass available in Red / Black / Blue / Grey

Trio Square Glass available in Red / Black / Blue / Butterscotch / Green / Grey / Sea Green

Contemporary Italia Accessories

Designer handle range for our key only operated and slam shut auto locks



ES3 800mm



ES24



ES23



This information is intended for illustration purposes only and may be subject to change for reasons beyond our control. As a consequence this brochure should be used for guidance only.

Pilkington Texture Glass Warwick™

This design is unique amongst our patterns because it is produced using a different manufacturing method. Pilkington Texture Glass Warwick™ is a random pattern that is added along the central portion of the pane and this has implications when cutting the glass down into finished sizes. It is possible, if a pane is small enough, it could be cut with no evidence of the pattern at all.

None of the Pilkington patterns are designed to have an orientation (an up side) but care needs to be taken with adjacent panes that the pattern direction is maintained. There is a linear nature to Pilkington Texture Glass Warwick™ and so householders should be aware that there could be aesthetic implications when choosing this design. Also, for the glass supplier the result may be that this pattern is less accommodating when cutting and may result in a greater proportion of seldge from the original glass plate.

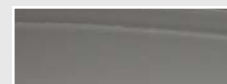

Warwick Glass available in all of our doors



Abstract Glass available in the Pisa, Turin and Siena



Satin Glass available in all of our doors



Traditional Collection

The Traditional collection from Solidor, brings classic designs into the modern era. Each door design is suited to both traditional and modern properties alike, and will add a touch of elegance to every home.

London

Its timeless beauty is down to its most distinguishing feature; the arched glazed panel

Glass Options

(see pages 42-45)

NEW GLASS

Caledonian Rose Handed	<input checked="" type="checkbox"/>	CTB 12.1	GB (Rosewood)
Dorchester	<input checked="" type="checkbox"/>	CTB 12.3	GB (White)
Etched Squares		CTB 12.3BG	Jewel
Linear		CTB 17.1	Potomac
London Etch Border		CTB 17.2	Prairie
Matrix		CTB 18.1	Quad (Black)
Modena		CTB 19.1	Quad (Blue)
Park Lane Bespoke	<input checked="" type="checkbox"/>	CTB 19.2	Quad (Grey)
The Victorian		CTL 3.1	Quad (Red)
Zinc Art Star		CTL 6.1	Reflections
		CTL 31.1B	Royale
		CTL 31.2B	Simplicity
Abstract		Diamond (Black & White)	Square Lead
Blind		Diamond (Black)	Star Black
Brilliante		Diamond (Butterscotch)	Star Clear
CFT 2.1		Diamond (Red)	Trio Square (Red)
CFT 2.2		Diamond Lead	Trio Square (Black)
CGB - B		Duplex GB B2B	Trio Square (Blue)
CGB - F		Geo Cassette	Trio Square (Green)
Clarity		Elegance	Trio Square (Grey)
CRL 2.1		GB (Brown)	Trio Square (Sea Green)
CRL 2.2		GB (Oak)	
CRL 2.3			
CSB 5.1FT			



London - Peacock Blue - Caledonian Rose



London
Golden Sand - Satin



London
French Grey - Park Lane

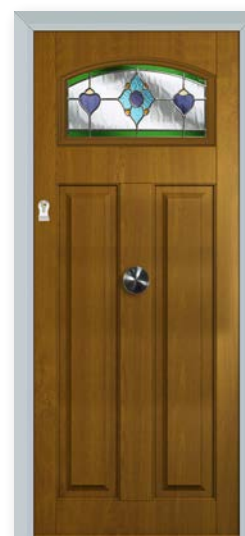

London
Golden Oak - Dorchester

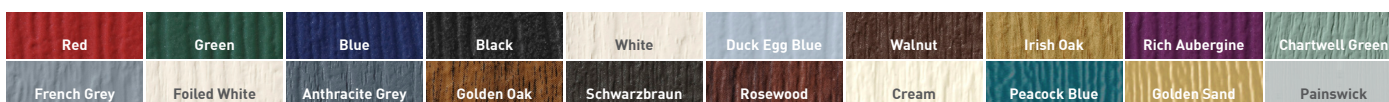

Alnwick

Makes for a great alternative to traditional designs and allows maximum natural light

Glass Options

(see pages 42-45)

NEW GLASS

Caledonian Rose Handed	CTB 12.1	GB (Rosewood)
Dorchester	CTB 12.3	GB (White)
Etched Squares	CTB 12.3BG	Jewel
Linear	CTB 17.1	Potomac
London Etch Border	CTB 17.2	Prairie
Matrix	CTB 18.1	Quad (Black)
Modena	CTB 19.1	Quad (Blue)
Park Lane Bespoke	CTB 19.2	Quad (Grey)
The Victorian	CTL 3.1	Quad (Red)
Zinc Art Star	CTL 6.1	Reflections
	CTL 31.1B	Royale
	CTL 31.2B	Simplicity
Abstract	Diamond (Black & White)	Square Lead
Blind	Diamond (Black)	Star Black
Brilliante	Diamond (Butterscotch)	Star Clear
CFT 2.1	Diamond (Red)	Trio Square (Red)
CFT 2.2	Diamond Lead	Trio Square (Black)
CGB - B	Duplex GB B2B	Trio Square (Blue)
CGB - F	Geo Cassette	Trio Square (Green)
Clarity	Elegance	Trio Square (Grey)
CRL 2.1	GB (Brown)	Trio Square (Sea Green)
CRL 2.2	GB (Oak)	
CRL 2.3		
CSB 5.1FT		



Alnwick - Schwarzbraun - Park Lane



Alnwick
Anthracite Grey - Satin



Alnwick
Rich Aubergine - Warwick



Alnwick
Chartwell Green - Modena

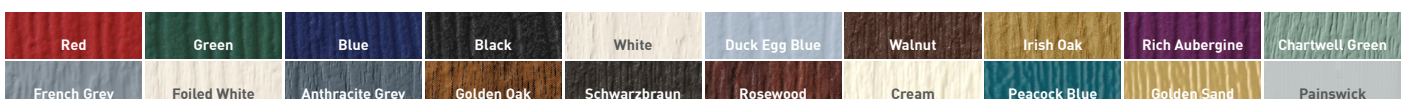

Edinburgh

A wonderful alternative to the classic Victorian four panel door style, thanks to its two elongated glazed units

Glass Options

(see pages 42-45)

NEW GLASS	CTB 12.1	GB (Rosewood)
Caledonian Rose Handed	CTB 12.3	GB (White)
Dorchester	CTB 12.3BG	Jewel
Etched Squares	CTB 17.1	Potomac
Linear	CTB 17.2	Prairie
London Etch Border ✓	CTB 18.1	Quad (Black)
Matrix	CTB 19.1	Quad (Blue)
Modena	CTB 19.2	Quad (Grey)
Park Lane Bespoke ✓	CTL 3.1	Quad (Red)
The Victorian	CTL 6.1	Reflections
Zinc Art Star	CTL 31.1B	Royale
	CTL 31.2B	Simplicity
Abstract	Diamond (Black & White)	Square Lead
Blind	Diamond (Black)	Star Black
Brilliante	Diamond (Butterscotch)	Star Clear
CFT 2.1	Diamond (Red)	Trio Square (Red)
CFT 2.2	Diamond Lead	Trio Square (Black)
CGB - B	Duplex GB B2B	Trio Square (Blue)
CGB - F	Geo Cassette	Trio Square (Butterscotch)
Clarity	Elegance	Trio Square (Green)
CRL 2.1	GB (Brown)	Trio Square (Grey)
CRL 2.2	GB (Oak)	Trio Square (Sea Green)
CRL 2.3		
CSB 5.1FT		



Edinburgh - Peacock Blue - Satin



Edinburgh Golden Sand



Edinburgh Cream



Edinburgh Anthracite Grey

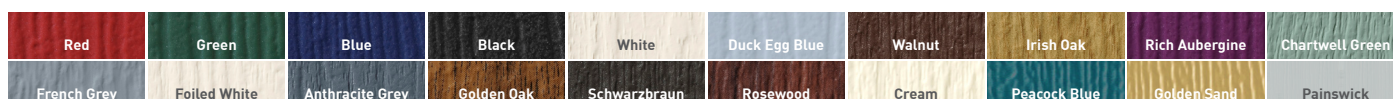

Berkeley

Contains two immaculately styled glazed units to help entice the natural light of the sun

Glass Options

(see pages 42-45)

NEW GLASS

Caledonian Rose Handed

Dorchester

Etched Squares

Linear

London Etch Border

Matrix

Modena

Park Lane Bespoke

The Victorian

Zinc Art Star

Abstract

Blind

Brilliante

CFT 2.1

CFT 2.2

CGB - B

CGB - F

Clarity

CRL 2.1

CRL 2.2

CRL 2.3

CSB 5.1FT

CTB 12.1

CTB 12.3

CTB 12.3BG

CTB 17.1

CTB 17.2

CTB 18.1

CTB 19.1

CTB 19.2

CTL 3.1

CTL 6.1

CTL 31.1B

CTL 31.2B

Diamond (Black & White)

Diamond (Black)

Diamond (Butterscotch)

Diamond (Red)

Diamond Lead

Duplex GB B2B

Geo Cassette

Elegance

GB (Brown)

GB (Oak)

GB (Rosewood)

GB (White)

Jewel

Potomac

Prairie

Quad (Black)

Quad (Blue)

Quad (Grey)

Quad (Red)

Reflections

Royale

Simplicity

Square Lead

Star Black

Star Clear

Trio Square (Red)

Trio Square (Black)

Trio Square (Blue)

Trio Square (Butterscotch)

Trio Square (Green)

Trio Square (Grey)

Trio Square (Sea Green)



Berkeley - Red - Matrix



Berkeley
Blue - Satin



Berkeley
Walnut - Caledonian Rose



Berkeley
Duck Egg Blue - Dorchester

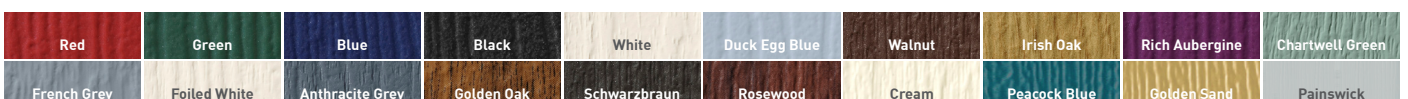

Conway

Sympathetically styled to complement most properties, from period to modern

Glass Options

(see pages 42-45)

NEW GLASS

Caledonian Rose Handed	<input checked="" type="checkbox"/>	CTB 12.3	<input checked="" type="checkbox"/>	Prairie	<input checked="" type="checkbox"/>
Dorchester	<input checked="" type="checkbox"/>	CTB 17.1		Quad (Black)	<input checked="" type="checkbox"/>
Etched Squares		CTB 17.2		Quad (Blue)	<input checked="" type="checkbox"/>
Linear		CTB 18.1		Quad (Grey)	<input checked="" type="checkbox"/>
London Etch Border		CTB 19.1		Quad (Red)	<input checked="" type="checkbox"/>
Matrix		CTB 19.2		Reflections	<input checked="" type="checkbox"/>
Modena		CTL 3.1		Royale	
Park Lane Bespoke		CTL 6.1	<input checked="" type="checkbox"/>	Simplicity	<input checked="" type="checkbox"/>
The Victorian		CTL 31.1B		Square Lead	<input checked="" type="checkbox"/>
Zinc Art Star	<input checked="" type="checkbox"/>	CTL 31.2B		Star Black	
		Diamond (Black & White)	<input checked="" type="checkbox"/>	Star Clear	
Abstract	<input checked="" type="checkbox"/>	Diamond (Black)	<input checked="" type="checkbox"/>	Trio Square (Red)	<input checked="" type="checkbox"/>
Blind		Diamond (Butterscotch)	<input checked="" type="checkbox"/>	Trio Square (Black)	<input checked="" type="checkbox"/>
Brilliante		Diamond (Red)	<input checked="" type="checkbox"/>	Trio Square (Blue)	<input checked="" type="checkbox"/>
CFT 2.1		Diamond Lead	<input checked="" type="checkbox"/>	Trio Square (Butterscotch)	
CFT 2.2		Duplex GB B2B		Trio Square (Green)	
CGB - B		Geo Cassette		Trio Square (Grey)	<input checked="" type="checkbox"/>
CGB - F	<input checked="" type="checkbox"/>	Elegance	<input checked="" type="checkbox"/>	Trio Square (Sea Green)	
Clarity	<input checked="" type="checkbox"/>	GB (Brown)			
CRL 2.1		GB (Oak)			
CRL 2.2		GB (Rosewood)			
CRL 2.3	<input checked="" type="checkbox"/>	GB (White)			
CSB 5.1FT	<input checked="" type="checkbox"/>				



Conway 3 - Foiled White - Caledonian Rose



Conway Solid
Rosewood



Conway 1
Peacock Blue - Elegance



Conway 3
Golden Sands - Diamond Black

Red	Green	Blue	Black	White	Duck Egg Blue	Walnut	Irish Oak	Rich Aubergine	Chartwell Green
French Grey	Foiled White	Anthracite Grey	Golden Oak	Schwarzbraun	Rosewood	Cream	Peacock Blue	Golden Sand	Painswick

Ludlow

This is our most popular door style which complements almost any property



Ludlow 2 - Painswick - London Etch Border



Ludlow 2 - Peacock Blue - Dorchester

Red	Green	Blue	Black	White	Duck Egg Blue	Walnut	Irish Oak	Rich Aubergine	Chartwell Green
French Grey	Foiled White	Anthracite Grey	Golden Oak	Schwarzbraun	Rosewood	Cream	Peacock Blue	Golden Sand	Painswick

Glass Options

(see pages 42-45)

NEW GLASS

Caledonian Rose Handed	✓	CGB - B	Diamond (Black & White)	✓	Quad (Grey)	✓	
Dorchester	✓	CGB - F	Diamond (Black)	✓	Quad (Red)	✓	
Etched Squares	✓	Clarity	✓	Diamond (Butterscotch)	✓	Reflections	✓
Linear	✓	CRL 2.2	Diamond (Red)	✓	Royale		
London Etch Border	✓	CRL 2.3	Diamond Lead	✓	Simplicity	✓	
Matrix	✓	CSB 5.1FT	Duplex GB B2B		Square Lead	✓	
Modena	✓	CTB 12.1	Geo Cassette		Star Black		
Park Lane Bespoke	✓	CTB 12.3	Elegance	✓	Star Clear		
The Victorian	✓	CTB 12.3BG	GB (Brown)		Trio Square (Red)	✓	
Zinc Art Star	✓	CTB 17.1	GB (Oak)		Trio Square (Black)	✓	
		CTB 17.2	✓	GB (Rosewood)		Trio Square (Blue)	✓
		CTB 18.1	GB (White)		Trio Square (Butterscotch)		
Abstract	✓	CTB 19.1	Jewel	✓	Trio Square (Green)		
Blind		CTB 19.2	✓	Potomac	✓	Trio Square (Grey)	✓
Brilliante	✓	CTL 3.1	Prairie	✓	Trio Square (Sea Green)		
CFT 2.1		CTL 6.1	Quad (Black)	✓			
CFT 2.2	✓	CTL 31.1B	Quad (Blue)	✓			



Ludlow 2
Rich Aubergine - Etched Square



Ludlow 2
Anthracite Grey - Brilliante



Ludlow 2
Golden Oak - Quad Grey

Nottingham

A unique door with real appeal for traditional properties with arched features

Glass Options

(see pages 42-45)

NEW GLASS

Caledonian Rose Handed <input checked="" type="checkbox"/>	CTB 12.3	Jewel <input checked="" type="checkbox"/>
Dorchester	CTB 12.3BG	Potomac <input checked="" type="checkbox"/>
Etched Squares	CTB 17.1	Prairie <input checked="" type="checkbox"/>
Linear	CTB 17.2 <input checked="" type="checkbox"/>	Quad (Black) <input checked="" type="checkbox"/>
London Etch Border	CTB 18.1	Quad (Blue) <input checked="" type="checkbox"/>
Matrix	CTB 19.1	Quad (Grey) <input checked="" type="checkbox"/>
Modena	CTB 19.2 <input checked="" type="checkbox"/>	Quad (Red) <input checked="" type="checkbox"/>
Park Lane Bespoke <input checked="" type="checkbox"/>	CTL 3.1	Reflections <input checked="" type="checkbox"/>
The Victorian	CTL 6.1	Royale
Zinc Art Star <input checked="" type="checkbox"/>	CTL 31.1B	Simplicity <input checked="" type="checkbox"/>
Abstract <input checked="" type="checkbox"/>	Diamond (Black & White) <input checked="" type="checkbox"/>	Square Lead <input checked="" type="checkbox"/>
Blind	Diamond (Black) <input checked="" type="checkbox"/>	Star Black
Brilliante <input checked="" type="checkbox"/>	Diamond (Butterscotch) <input checked="" type="checkbox"/>	Star Clear
CFT 2.1	Diamond (Red) <input checked="" type="checkbox"/>	Trio Square (Red) <input checked="" type="checkbox"/>
CFT 2.2 <input checked="" type="checkbox"/>	Diamond Lead <input checked="" type="checkbox"/>	Trio Square (Black) <input checked="" type="checkbox"/>
CGB - B	Duplex GB B2B	Trio Square (Blue) <input checked="" type="checkbox"/>
CGB - F	Geo Cassette	Trio Square (Butterscotch)
Clarity <input checked="" type="checkbox"/>	Elegance <input checked="" type="checkbox"/>	Trio Square (Green)
CRL 2.2	GB (Brown)	Trio Square (Grey) <input checked="" type="checkbox"/>
CRL 2.3	GB (Oak)	Trio Square (Sea Green)
CSB 5.1FT	GB (Rosewood)	
CTB 12.1	GB (White)	



Nottingham - Chartwell Green - Simplicity



Nottingham
Red - Quad Black



Nottingham
French Grey - Brilliante



Nottingham
Schwarzbraun - CTB 19.2

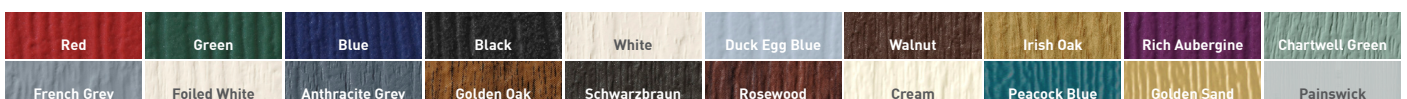

Harlech

A very popular choice for properties with gable end features

Glass Options

(see pages 42-45)

NEW GLASS

Caledonian Rose Handed	✓	CTB 12.3	Jewel	✓
Dorchester		CTB 12.3BG	Potomac	✓
Etched Squares		CTB 17.1	Prairie	✓
Linear		CTB 17.2	Quad (Black)	✓
London Etch Border		CTB 18.1	Quad (Blue)	✓
Matrix		CTB 19.1	Quad (Grey)	✓
Modena		CTB 19.2	Quad (Red)	✓
Park Lane Bespoke	✓	CTL 3.1	Reflections	✓
The Victorian		CTL 6.1	Royale	
Zinc Art Star	✓	CTL 31.1B	Simplicity	✓
Abstract	✓	Diamond (Black & White)	Square Lead	✓
Blind		Diamond (Black)	Star Black	
Brilliante	✓	Diamond (Butterscotch)	Star Clear	
CFT 2.1		Diamond (Red)	Trio Square (Red)	✓
CFT 2.2	✓	Diamond Lead	Trio Square (Black)	✓
CGB - B		Duplex GB B2B	Trio Square (Blue)	✓
CGB - F		Geo Cassette	Trio Square (Butterscotch)	
Clarity	✓	Elegance	Trio Square (Green)	
CRL 2.1		GB (Brown)	Trio Square (Grey)	✓
CRL 2.3		GB (Oak)	Trio Square (Sea Green)	
CSB 5.1FT		GB (Rosewood)		
CTB 12.1		GB (White)		



Harlech - French Grey - Zinc Art Star



Harlech
Black - Diamond Black

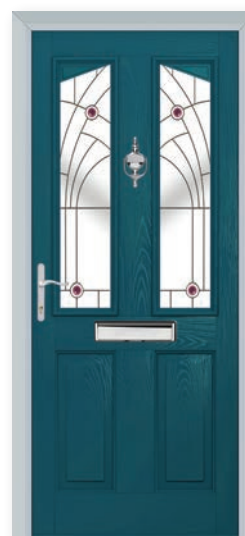

Harlech
Peacock Blue - Jewel

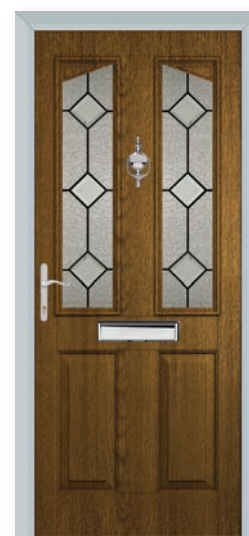

Harlech
Walnut - CTB 17.2

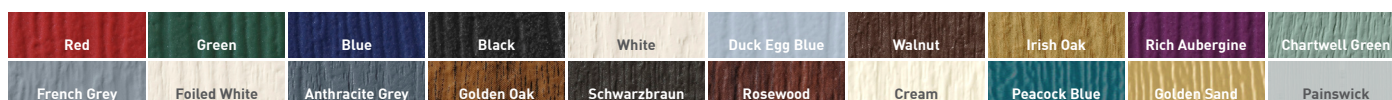

Tenby

A timeless classic of a design which will complement every home

Glass Options

(see pages 42-45)

NEW GLASS

Caledonian Rose Handed	<input checked="" type="checkbox"/>	CTB 12.1	GB (Rosewood)
Dorchester	<input checked="" type="checkbox"/>	CTB 12.3	GB (White)
Etched Squares		CTB 12.3BG	Jewel
Linear		CTB 17.1	Potomac
London Etch Border		CTB 17.2	Prairie
Matrix	<input checked="" type="checkbox"/>	CTB 18.1	Quad (Black)
Modena	<input checked="" type="checkbox"/>	CTB 19.1	Quad (Blue)
Park Lane Bespoke		CTB 19.2	Quad (Grey)
The Victorian		CTL 3.1	Quad (Red)
Zinc Art Star	<input checked="" type="checkbox"/>	CTL 6.1	Reflections
		CTL 31.1B	Royale
		CTL 31.2B	Simplicity
Abstract		Diamond (Black & White)	Square Lead
Blind		Diamond (Black)	Star Black
Brilliante		Diamond (Butterscotch)	Star Clear
CFT 2.1		Diamond (Red)	Trio Square (Red)
CFT 2.2		Diamond Lead	Trio Square (Black)
CGB - B		Duplex GB B2B	Trio Square (Blue)
CGB - F	<input checked="" type="checkbox"/>	Geo Cassette	Trio Square (Green)
Clarity		Elegance	Trio Square (Grey)
CRL 2.1		GB (Brown)	Trio Square (Sea Green)
CRL 2.2	<input checked="" type="checkbox"/>	GB (Oak)	
CRL 2.3			
CSB 5.1FT			



Tenby 4 - Schwarzbraun - Modena



Tenby 4
Painswick - Quad Grey



Tenby 2
Rich Aubergine - Reflections



Tenby 2
Duck Egg Blue - Caledonian Rose

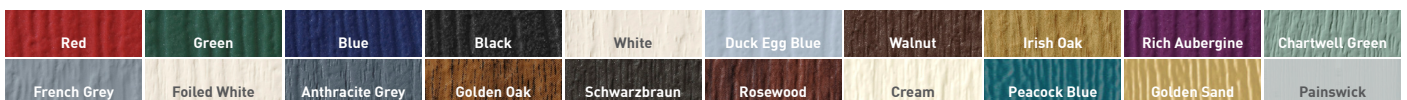

Beeston

A great choice for a front or back door, the most popular choice as a stable door

Glass Options

(see pages 42-45)

No B2B spacer is available in Satin, warwick or laminated glass

NEW GLASS			
Caledonian Rose Handed		CTB 12.1	GB (Rosewood) ✓
Dorchester		CTB 12.3	GB (White) ✓
Etched Squares		CTB 12.3BG	Jewel ✓
Linear	✓	CTB 17.1	Potomac
London Etch Border	✓	CTB 17.2	Prairie
Matrix		CTB 18.1	Quad (Black)
Modena	✓	CTB 19.1	Quad (Blue) ✓
Park Lane Bespoke	✓	CTB 19.2	Quad (Grey) ✓
The Victorian		CTL 3.1	Quad (Red) ✓
Zinc Art Star		CTL 6.1	Reflections ✓
		CTL 31.1B	Royale
		CTL 31.2B	Simplicity ✓
Abstract	✓	Diamond (Black & White)	Square Lead ✓
Blind	✓	Diamond (Black)	Star Black
Brilliante	✓	Diamond (Butterscotch)	Star Clear
CFT 2.1		Diamond (Red)	Trio Square (Red)
CFT 2.2		Diamond Lead	Trio Square (Black)
CGB - B		Duplex GB B2B	Trio Square (Blue)
CGB - F		Geo Cassette	Trio Square (Butterscotch) ✓
Clarity		Elegance	Trio Square (Green) ✓
CRL 2.1		GB (Brown)	Trio Square (Grey)
CRL 2.2		GB (Oak)	Trio Square (Sea Green) ✓
CRL 2.3			
CSB 5.1FT			



Beeston 1 - White - Reflections



Beeston GB
Duck Egg Blue - Clear



Beeston 1
Rosewood - Integrated Blind

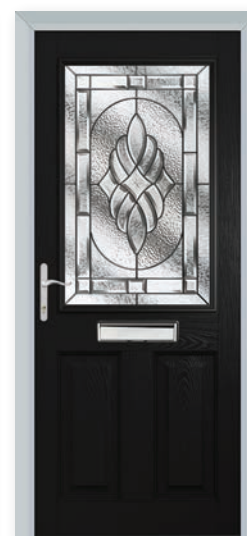

Beeston 1
Black - Elegance

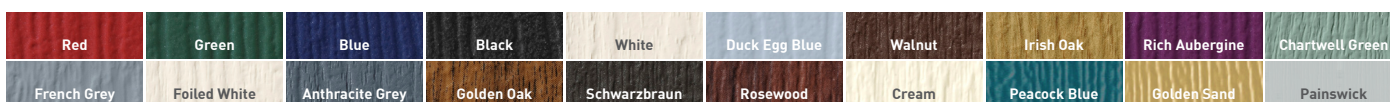

Traditional Flint

A great option for cottages, farmhouses, side doors and stable doors

Glass Options

(see pages 42-45)

	Flint 1	Flint 2	Flint 3	Flint 4	Flint 5	Square
Abstract				✓		
Black Star	✓		✓			✓
Brilliante				✓		
Bullseye	✓		✓			✓
Clarity				✓		
Clear Star	✓		✓			✓
CRL 2.1				✓		
CTB 17.1				✓		
CTB 18.1		✓				
CTB 19.1				✓		
CTF 2.1				✓		
CTL 31.1B				✓		
Diamond Glass				✓		
Elegance				✓		
London Etch Border	✓					✓
Modena					✓	
Park Lane Bespoke				✓	✓	
Potomac				✓	✓	
Prairie				✓		
Quad Glass				✓		
Reflections				✓	✓	
Simplicity				✓		
The Victorian				✓		
Trio Square Group 1	✓		✓			✓
Trio Square Group 2				✓		



Flint Solid - Duck Egg Blue



Flint 1
Anthracite Grey - Bullseye

Diamond Glass available in
Red / Black / Butterscotch / Black & White

Quad Glass available in
Red / Black / Blue / Grey

Trio Square Glass Group 1 available in
Butterscotch / Green / Sea Green

Trio Square Glass Group 2 available in
Red / Black / Blue / Grey

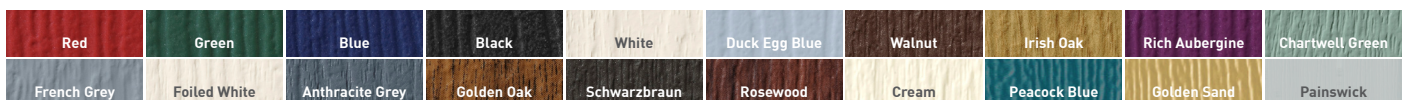



Flint 2
Golden Sand - CTB18.1



Flint 3
Chartwell Green - Trio Square Green



Flint 4
Golden Oak - Park Lane



Flint 5
Painswick - Modena



Flint Square
Peacock Blue - Bullseye



Flint Beeston
Red - Brillante

Stafford

A stylish alternative for any door and looks great on any property

Glass Options

(see pages 42-45)

NEW GLASS

Caledonian Rose Handed	CTB 12.1	GB (Rosewood)
Dorchester	CTB 12.3	GB (White)
Etched Squares	CTB 12.3BG	Jewel
Linear	CTB 17.1	Potomac
London Etch Border	CTB 17.2	Prairie
Matrix	CTB 18.1	Quad (Black) ✓
Modena ✓	CTB 19.1	Quad (Blue) ✓
Park Lane Bespoke ✓	CTB 19.2	Quad (Grey) ✓
The Victorian	CTL 3.1	Quad (Red) ✓
Zinc Art Star ✓	CTL 6.1	Reflections ✓
Abstract ✓	CTL 31.1B	Royale ✓
Blind	CTL 31.2B	Simplicity ✓
Brilliante ✓	Diamond (Black & White) ✓	Square Lead ✓
CFT 2.1	Diamond (Black) ✓	Star Black
CFT 2.2	Diamond (Butterscotch) ✓	Star Clear
CGB - B	Diamond (Red) ✓	Trio Square (Red) ✓
CGB - F	Diamond Lead ✓	Trio Square (Black) ✓
Clarity ✓	Duplex GB B2B	Trio Square (Blue) ✓
CRL 2.1	Geo Cassette	Trio Square (Grey) ✓
CRL 2.2	Elegance ✓	
CRL 2.3	GB (Brown)	
CSB 5.1FT	GB (Oak)	



Stafford - Schwarzbraun - Park Lane



Stafford
French Grey - Royale



Stafford
Foiled White - Elegance



Stafford
Rich Aubergine - Clarity

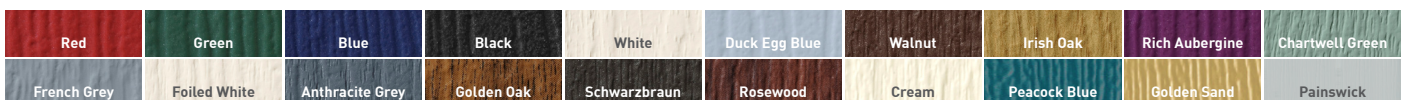

Windsor

A great option for modern and traditional properties alike.
 (Windsor glazed is not available with vertical grooves)



Windsor - Golden Sand



Windsor Glazed - French Grey

Thornbury

Add an elegant yet subtle finish to any entrance



Thornbury - Schwarzbraun

Red	Green	Blue	Black	White	Duck Egg Blue	Walnut	Irish Oak	Rich Aubergine	Chartwell Green
French Grey	Foiled White	Anthracite Grey	Golden Oak	Schwarzbraun	Rosewood	Cream	Peacock Blue	Golden Sand	Painswick

French Doors

BOND HOUSE



All of our designs, in all of our colours are available in a French Door option, with a range of handle options, encompassing a high security, adjustable, multipoint locking system.



Available as inward or outward opening doors. Because our French door range is so vast, please contact us for the minimum and maximum sizes before you order your set.

NOTE: Available with UPVC and aluminium threshold on inward opening sets, and UPVC only on outward opening sets.



Flush, integrated two way lever, which throws the shootbolts and removes the need for a lever handle and cylinder to give the option to use our Italia Collection handles on both leaves, alternatively, go for lever operated!

Standard option is both doors to be lever handle operated.

Stable Doors

The majority of our standard and many of the italia Collection door styles are available as open in (only) stable doors. Available in any colour on any side.

[contact us for more details]

All of our stable doors come with a high security, fully adjustable multi-point locking system. They are also keyed alike, benefit from an internal thumb turn cylinder on the top and bottom half and have a latching security bolt as standard.

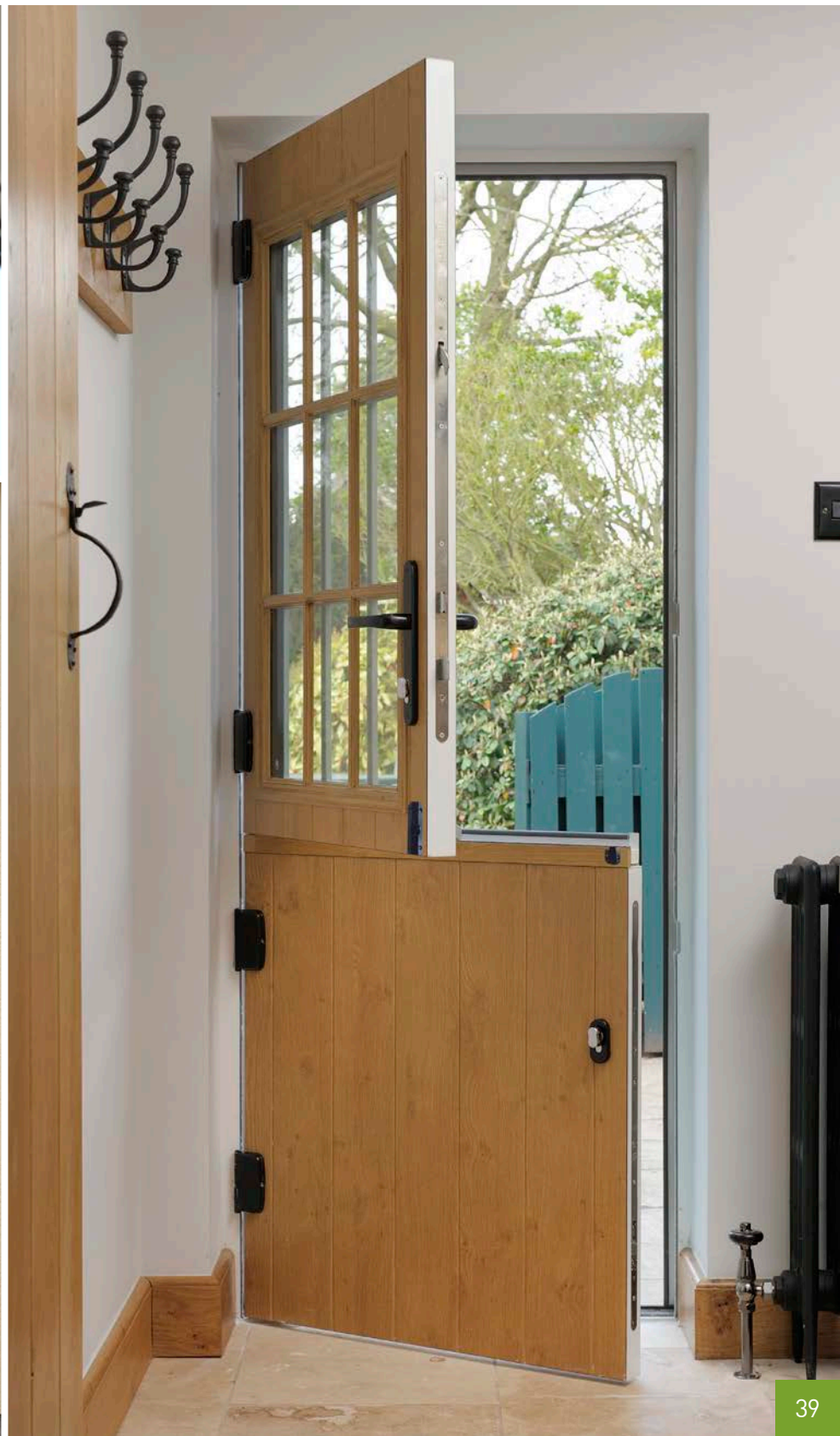
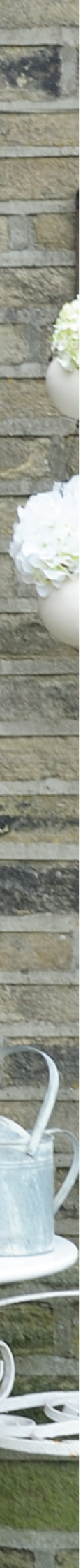

Side Panels



Complement your property with a full range of matching full height and half side panels.

(contact us for details on the full range of side panels available)



Half Moulded



Half Flat Grain



Quarter Moulded



Milano Side Panel



Milano



Brescia



Thornbury



Ludlow



Harlech



Available in all of our colour options!

Tenby



Nottingham

Glass

A fine selection of stylish glass to help you personalise your choice of door. Whether modern or traditional you will find a glass design to really make your door stand out. Our full range of glass comes with Low E. Warmedge spacer and is Argon filled as standard

Trio Square

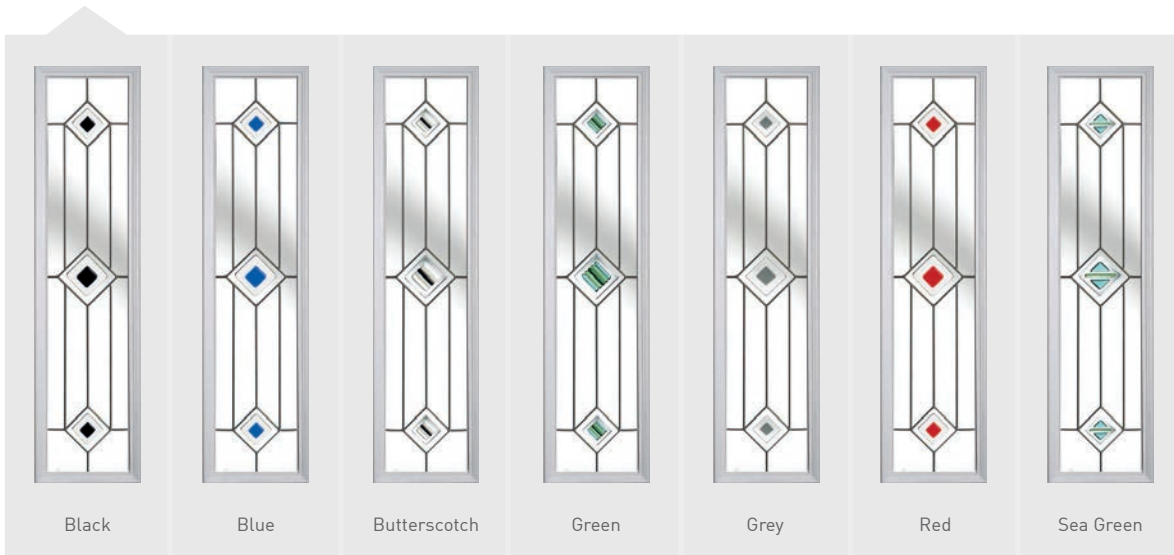

Diamond

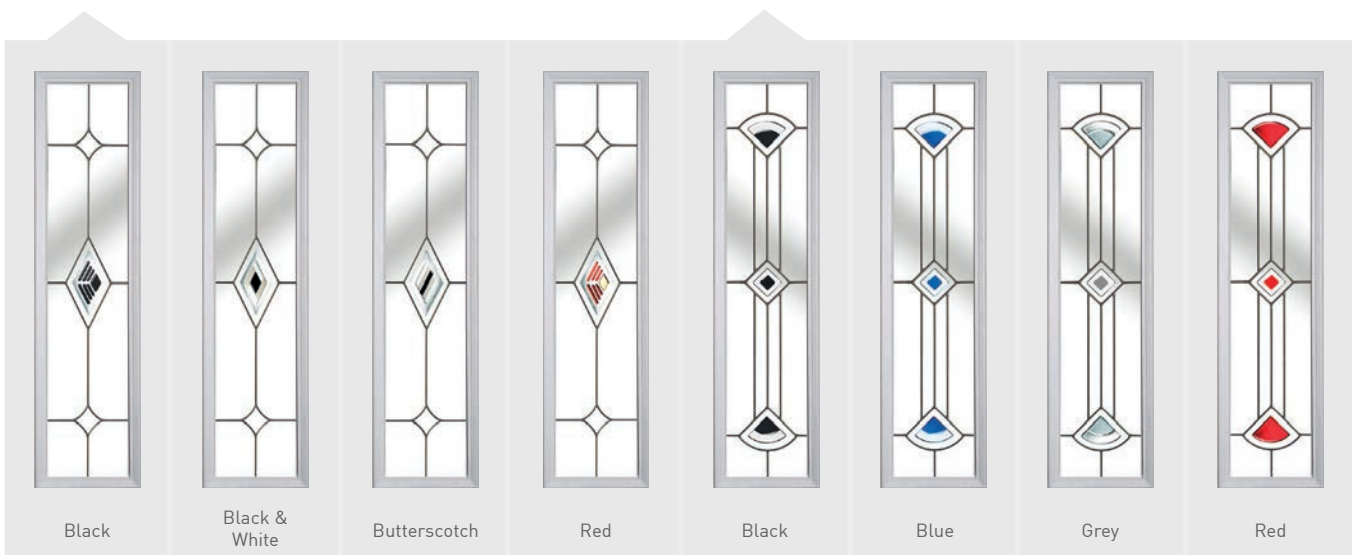

Quad

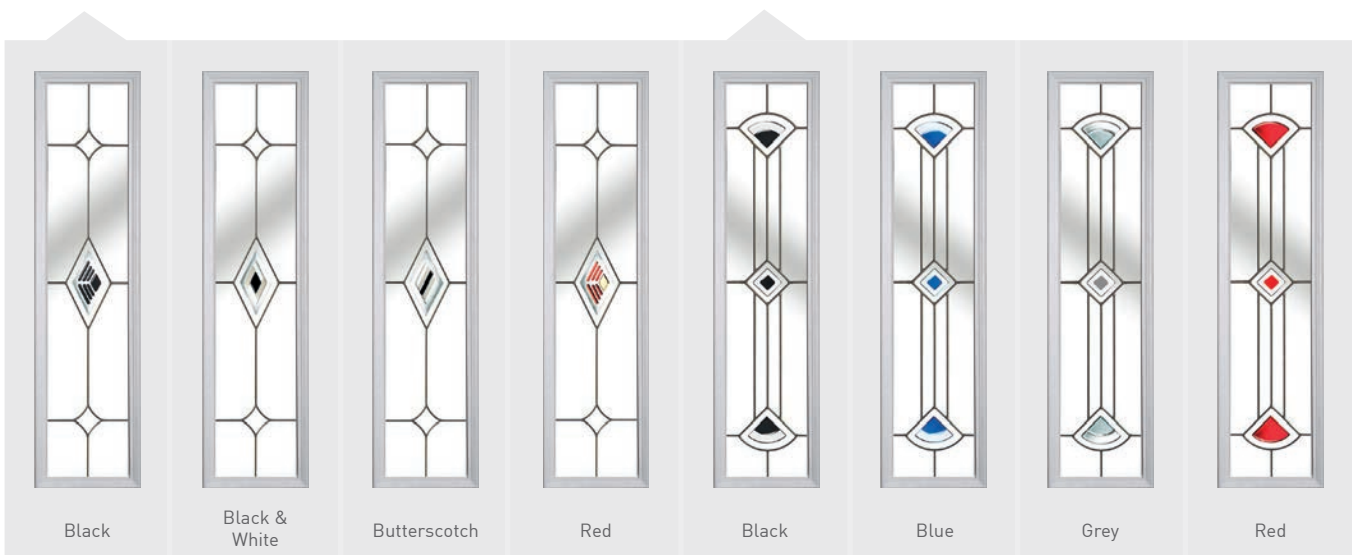

New Glass Designs

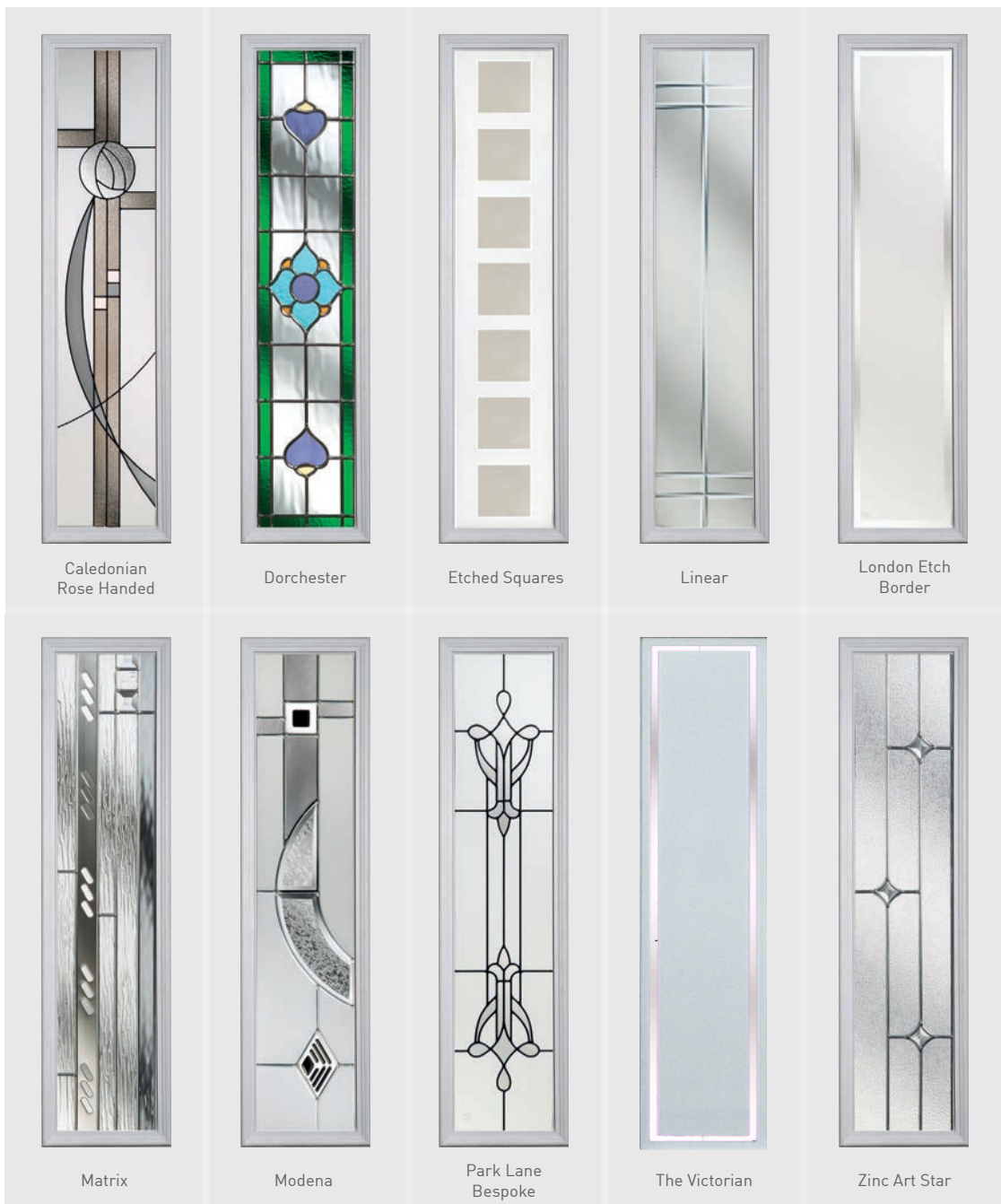

Backing glass not optional

Blind

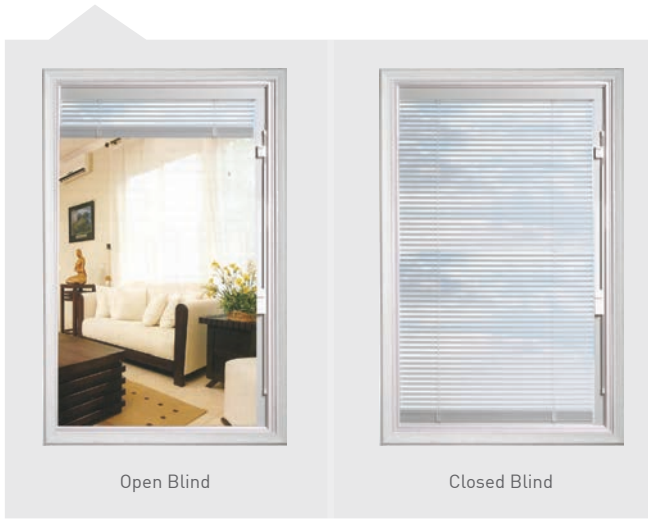

Decorative (backing glass not optional, clear as standard)

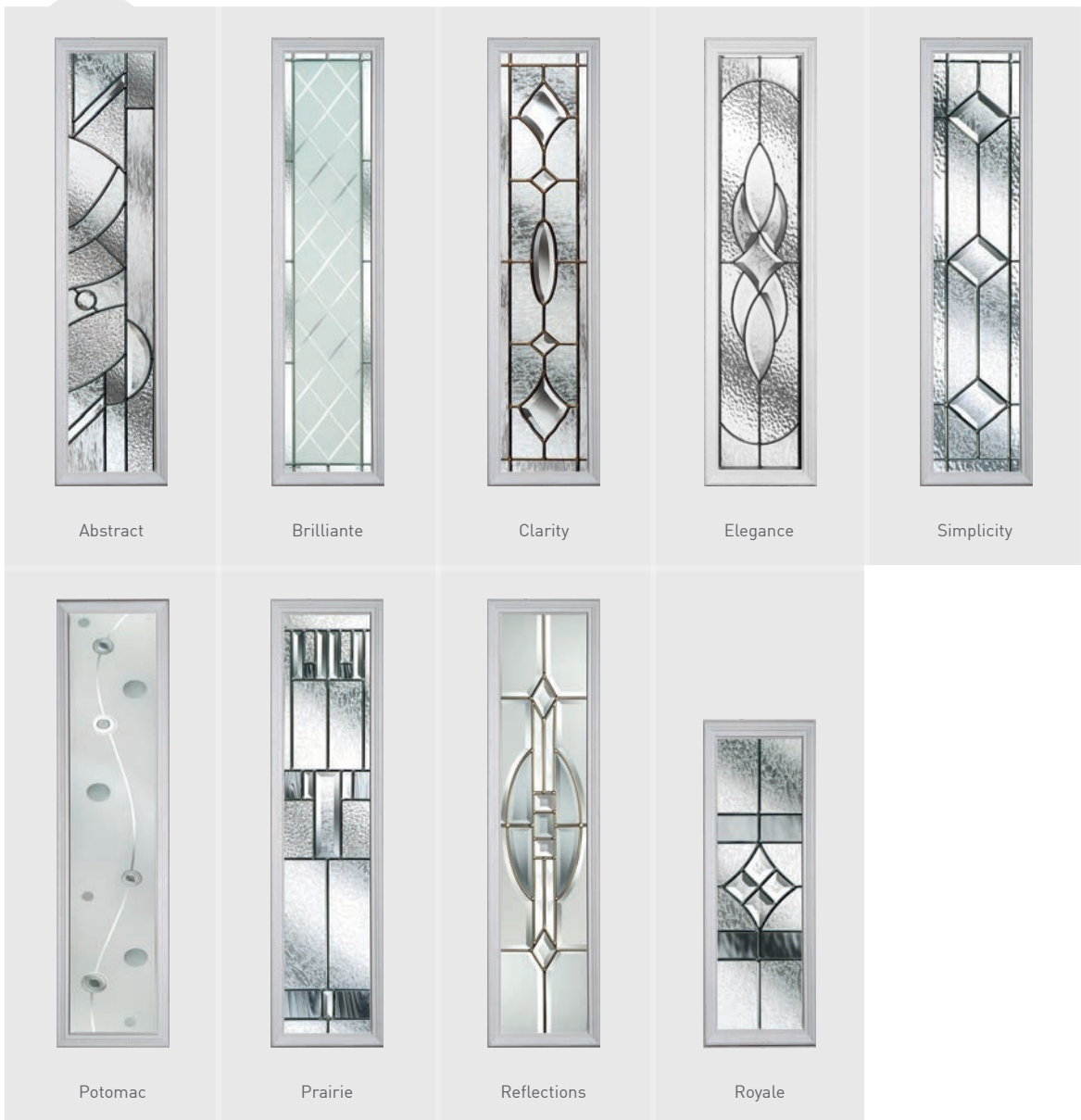

CTB & Star

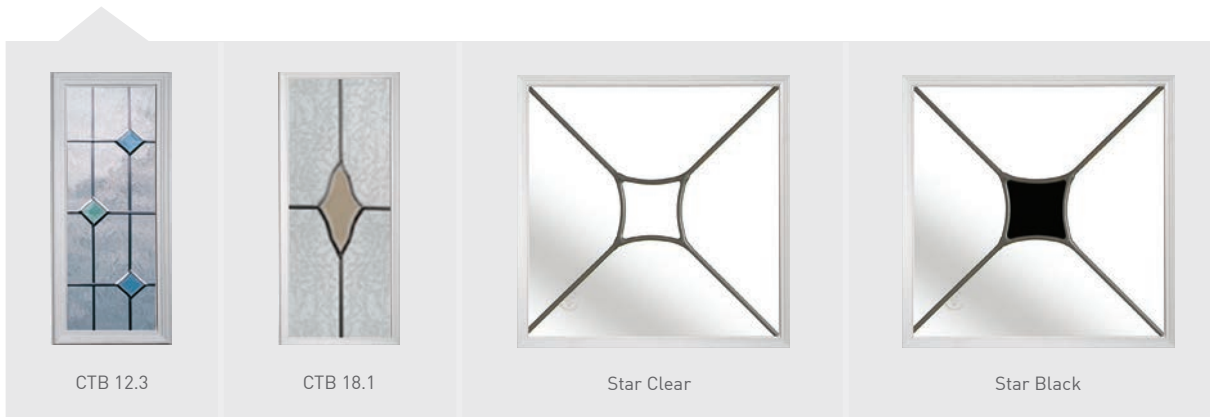

CFT, CGB, CSB, CTB, CTL

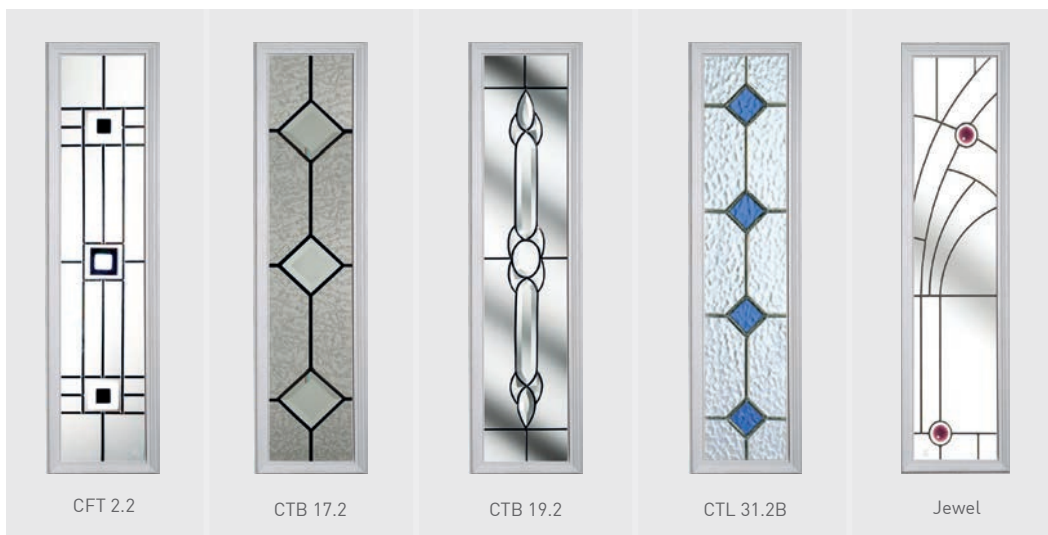

Glass designs key

CTL - Traditional Leaded designs

CTB - Glass bevel designs

CSB - Sandblast designs

Liquid Lead and Glass / tiles - Diamond, Quad, Square, CRL, Jewel.

Liquid lead, sandblast and stainless / glass tiles - With all of the above, a Pilkington backing glass should be selected.

Matrix, Modena, Potomac, Royale, Clarity, Elegance, Prairie, Simplicity, Brilliance, Abstract, Infinity, Reflections - Are all triple glazed and have no optional backing glass.

Accessories and Locks

A selection of beautiful accessories and high security locks to perfectly complement your choice of door. Whether contemporary or traditional you will find an accessory to really make your door stand out.

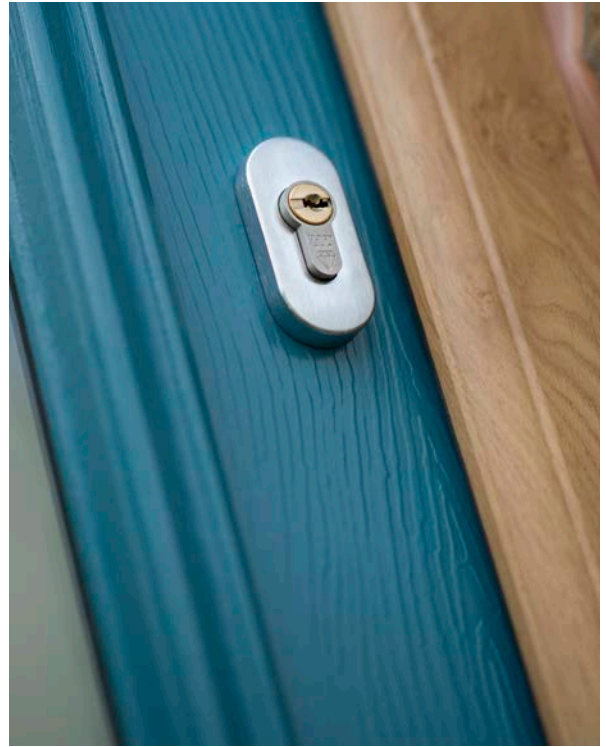

Locks



Heritage Slam Shut Lock

The aesthetics of a traditional rim latch, but incorporates the latest high security slam shut technology. The lock automatically engages as the door closes.



Key Operated Multi

Customers who do not want a handle, can upgrade to our Key operated Multi point lock.



Standard Slam Shut Auto lock

The Slam Shut lock is an automatic multi-point locking system. It features two self-locking hooks to provide additional security and two sealing elements ensure correct closure.









The Largest Deadbolt in the UK!

On lever handle doors, we fit our Avantis Secured by Design lock, which has the industries largest 25.4mm deadbolt for added security. It also has built in compression and dampeners to give the smoothest operation on the market.

Door knockers



Doctor



-  Chrome
-  Gold
-  Brushed
-  Black Chrome
-  White
-  Black

Premium 7" Doctor









-  Chrome
-  Gold

Urn







Available with or without spyhole



-  Chrome
-  Gold
-  Brushed
-  Black Chrome
-  White
-  Black
-  Antique Black

Pony Tail



-  Chrome
-  Gold
-  Brushed
-  Black Chrome
-  White
-  Black

Stainless Steel









-  Steel

Lion





Not available on Tenby 4, Conway 3, Ludlow, Edinburgh, Harlech or Nottingham



-  Chrome
-  Gold
-  Black Chrome
-  White
-  Black
-  Brushed Ali







Viewer



-  Chrome
-  Gold
-  White
-  Black





Letterplates



-  Chrome
-  Gold
-  Brushed
-  Black Chrome
-  White
-  Black
-  Antique Black

Butt hinge









-  Gold
-  White
-  Black
-  Brushed Ali

Hinges

Our new slimline, Pas 23-24 tested, face fixed flag hinge is sleek and modern.







-  Chrome
-  Gold
-  Brushed
-  Black Chrome
-  White
-  Black

Handles

A large range of premium quality handles to complement our doors. Available with a choice of a standard lever or one of the three exclusive options across the whole range of finishes.







Swan Hardex



-  Chrome
-  Gold
-  Brushed
-  Black Chrome
-  Antique Black







Lever Hardex



-  Chrome
-  Gold
-  Brushed
-  Black Chrome
-  White
-  Black
-  Antique Black



Lever Pad



-  Chrome
-  Gold
-  Brushed
-  Black Chrome
-  White
-  Black
-  Antique Black

Door Knob



-  Chrome
-  Brushed

Trojan Letterplates

Stainless steel specifically for coastal properties



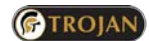

-  Chrome
-  Gold
-  Brushed



Trojan Urn

Stainless steel specifically for coastal properties



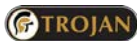

-  Gold
-  Chrome
-  Brushed



Trojan Handles

Stainless steel specifically for coastal properties







-  Gold
-  Chrome
-  Brushed



Extra Security

Security Door Guard



-  Chrome
-  Gold
-  Brushed
-  White
-  Black

Stable Door Latch



Suited where possible



Ironmongery

We have a range of stunning traditional knockers and handles that add a real touch of class.

Traditional Avon Slimline

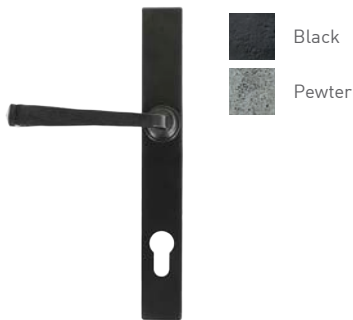

Traditional Monkey Tail



Traditional Cottage

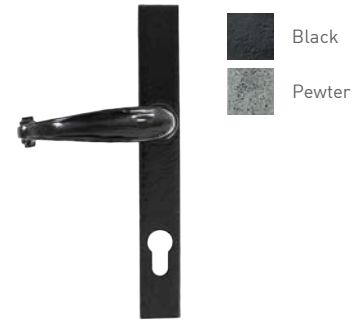

Traditional Pull Knob



Peardrop Knocker

Not available on Tenby 4, Conway 3, Ludlow, Edinburgh, Harlech or Nottingham



Traditional Ring

Not available on Tenby 4, Conway 3, Ludlow, Edinburgh, Harlech or Nottingham



Traditional Letterplate

Letterplate for illustrative purposes only
Opens outwards



Rim Pull

Available with the heritage lock

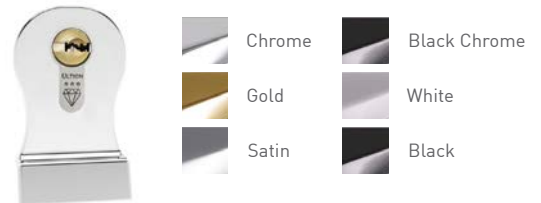

Finishing Options

OUTER FRAME OPTIONS

Which frame would you like? Choose from Kömmerling Chamfered C70 or Sculptured O70 outer frame.



Chamfered



Sculptured

EDGE BANDING COLOURS

White as standard, brown on Rosewood / Walnut and Schwarzbraun when coloured both sides, caramel on Golden Oak and Irish Oak when coloured both sides. For all other dual colour combination white edge band is use.

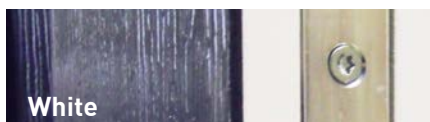

White



Brown



Caramel

Thresholds

To allow for every circumstance we offer the largest range of door thresholds. The AM3 and AM5EX aluminium threshold are both Part 'M' compliant within the latest Building Regulations for easy access.

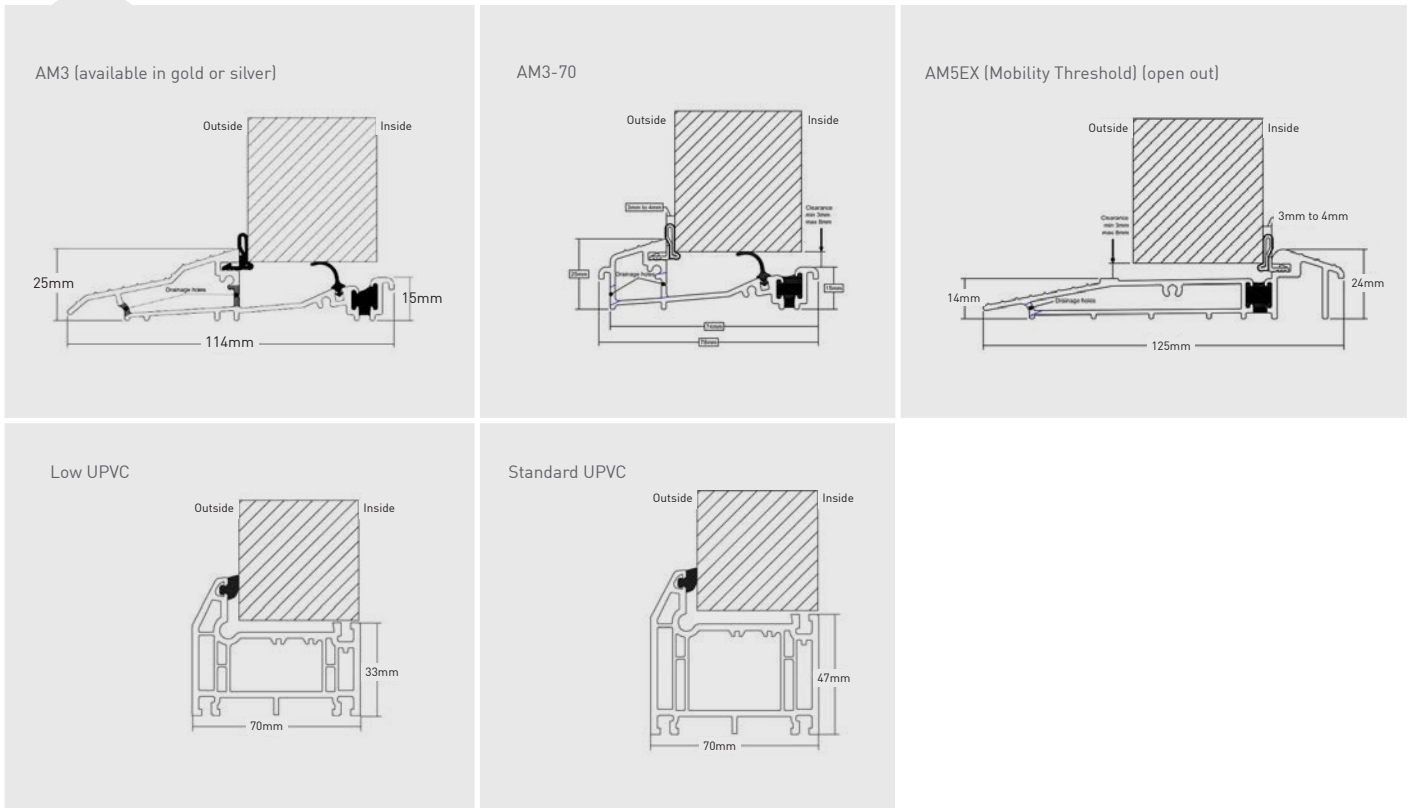

Authentic deep nose cill for your **Solidor**

Old imperial bricks varied in height, metric bricks are 65mm. Old timber cills were deep and often aligned with a course of bricks.

At 55mm The Radlington is a modern interpretation of a traditional cill, so if you are replacing your timber cill, the end result will look beautifully authentic.

Upgrade your Solidor with a Radlington cill today, available in 8 stunning Solidor colour colours to match your frame.

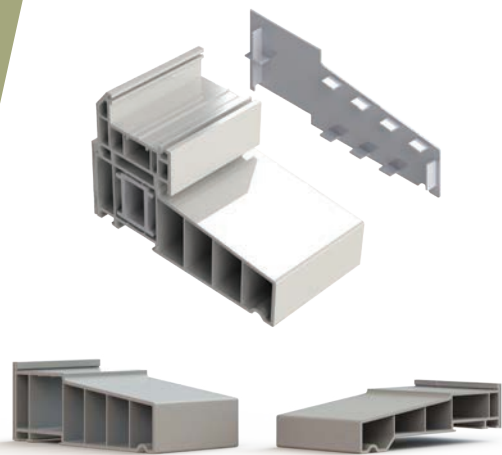

“Compared to the generic slimline cills, there is simply no comparison.”

Gareth Mobley, CEO - Solidor





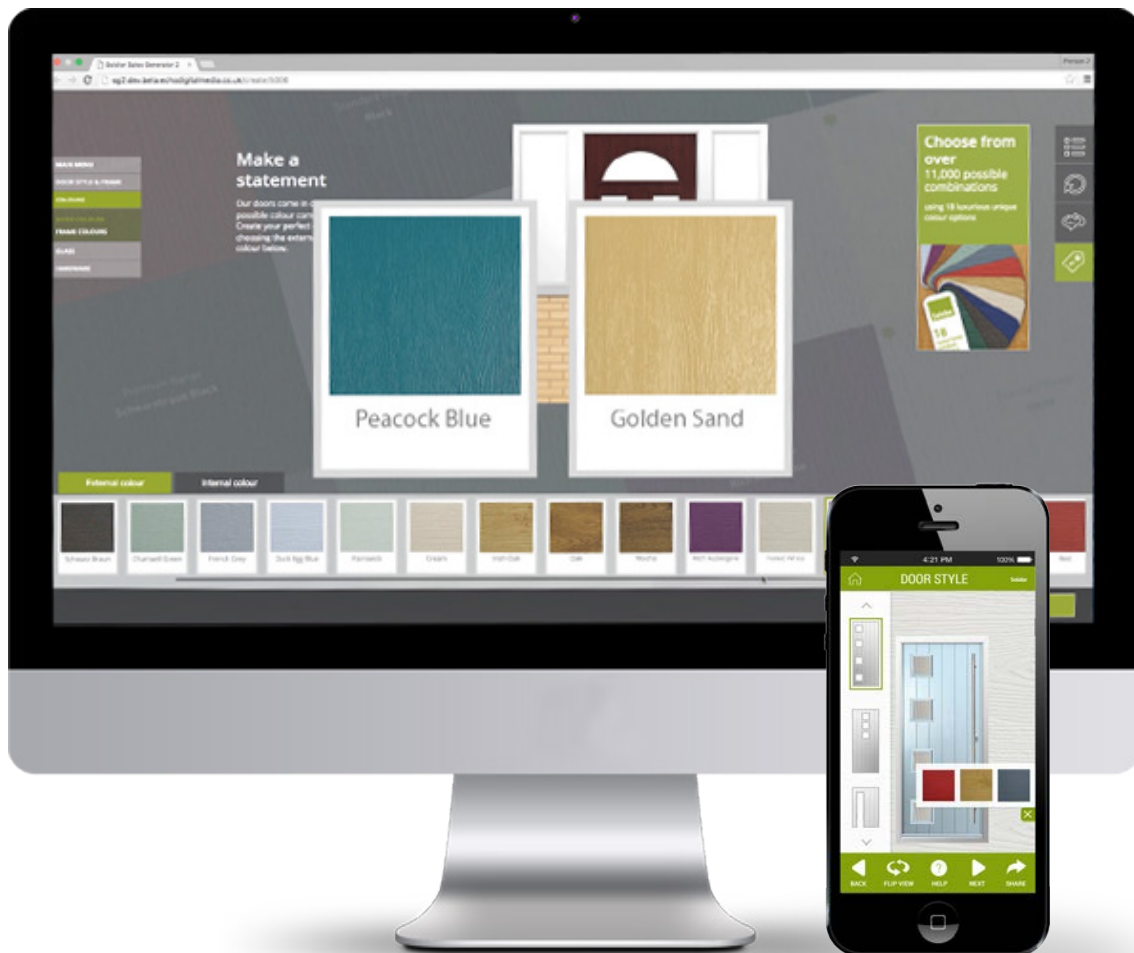

To create your perfect Solidor go online
or visit the App store

www.doordesigner.solidor.co.uk

